

Data Sheet



Article number: 03449040

Description: Fluro Heavy Duty Spherical Plain Bearing GE 40 SWE
Hole Ø40

Note: 40

Measures

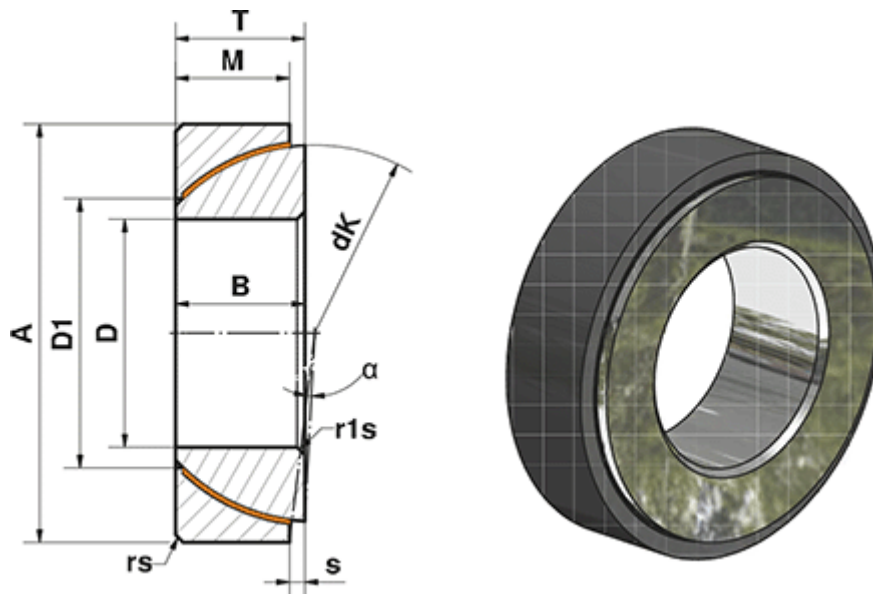

A	= 68	rs, r1s min	= 1
a (degrees)	= 3.5	S	= 2.8
B	= 19	Static load C0 (kN)	= 424
D	= 40	T	= 19
D1	= 47.7	Weight (g)	= 327
dK	= 62		
Dynamic load C (kN)	= 254		
M	= 17		